

FH1394

MULTIFRY

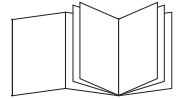

De'Longhi



For more recipes:
(free download)



De'Longhi Recipes multifry.delonghi.com



ELECTRICAL CONNECTION (UK ONLY)

A) If your appliance comes fitted with a plug, it will incorporate a 13 Amp fuse. If it does not fit your socket, the plug should be cut off from the mains lead, and an appropriate plug fitted, as below.

WARNING: Very carefully dispose of the cut off plug after removing the fuse: do not insert in a 13 Amp socket elsewhere in the house as this could cause a shock hazard.

With alternative plugs not incorporating a fuse, the circuit must be protected by a 15 Amp fuse. If the plug is a moulded-on type, the fuse cover must be re-fitted when changing the fuse using a 13 Amp Asta approved fuse to BS 1362. In the event of losing the fuse cover, the plug must NOT be used until a replacement fuse cover can be obtained from your nearest electrical dealer. The colour of the correct replacement fuse cover is that as marked on the base of the plug.

B) If your appliance is not fitted with a plug, please follow the instructions provided below:

WARNING - THIS APPLIANCE MUST BE EARTHED
IMPORTANT

The wires in the mains lead are coloured in accordance with the following code:

Green and yellow:	Earth
Blue:	Neutral
Brown:	Live

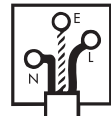

As the colours of the wires in the mains lead may not correspond with the coloured markings identifying the terminals in your plug, proceed as follows:

The green and yellow wire must be connected to the terminal in the plug marked with the letter E or the earth symbol  or coloured green or green and yellow.

The blue wire must be connected to the terminal marked with the letter N or coloured black.

The brown wire must be connected to the terminal marked with the letter L or coloured red.

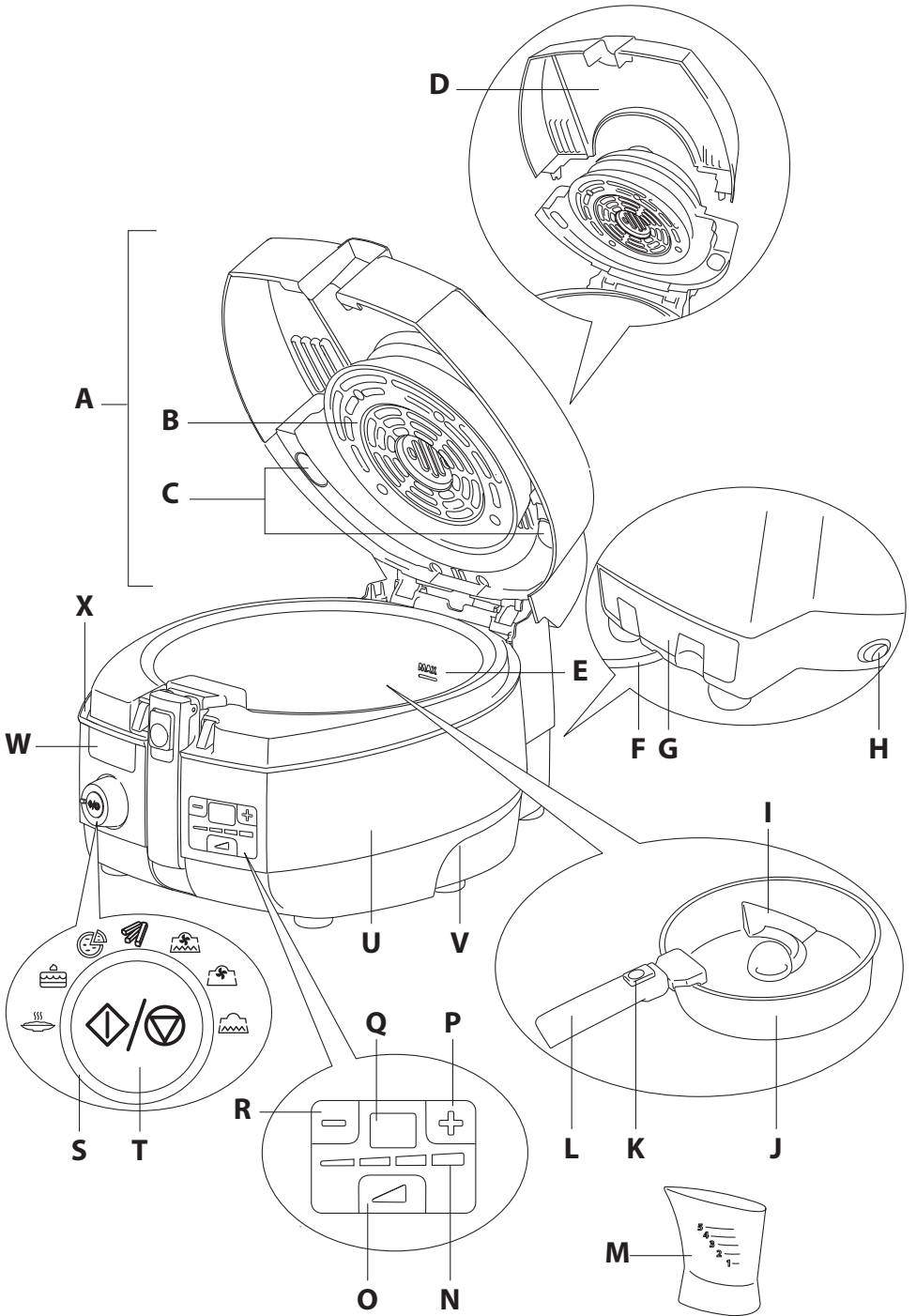

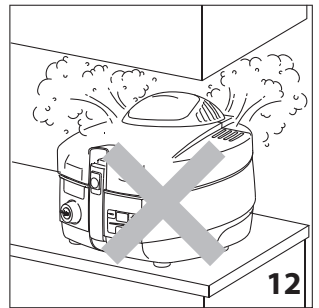
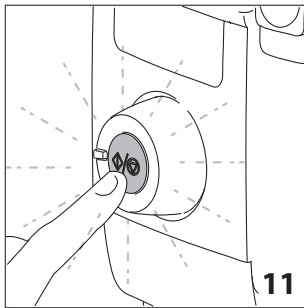
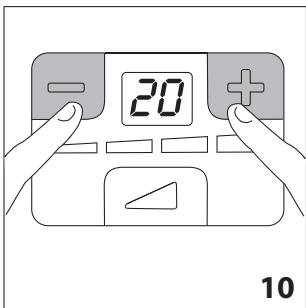
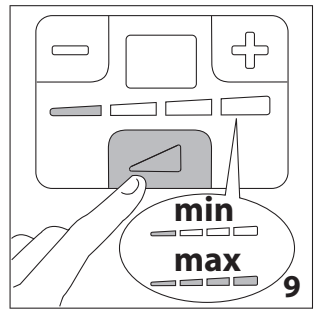
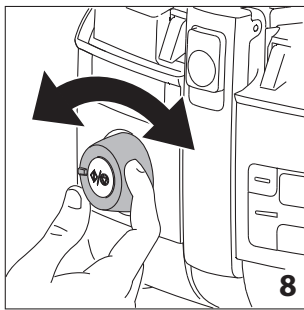
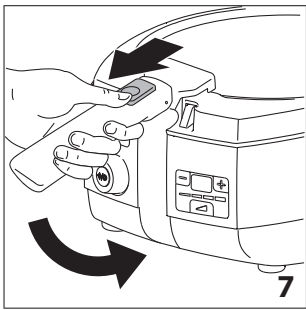
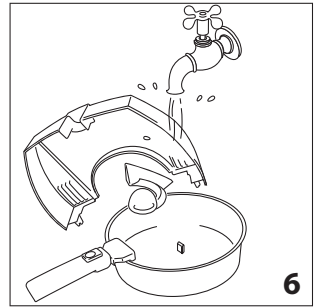
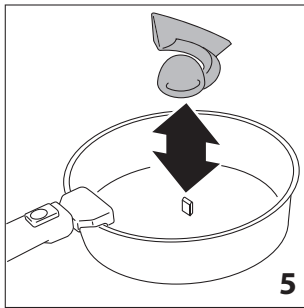
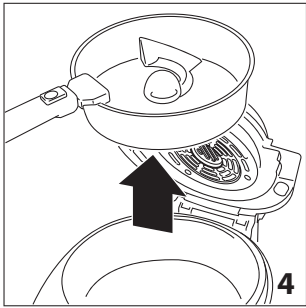
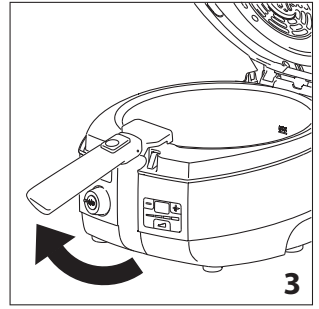
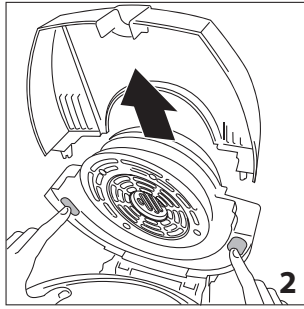
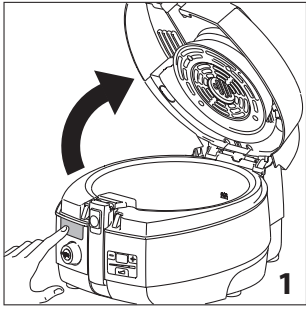

IMPORTANT SAFEGUARDS

Read all the Instruction for Use carefully before using the appliance. Keep this Instruction for Use.

- If the power cord is damaged, it must be replaced by the manufacturer or the manufacturer's Customer Services in order to avoid all risk.
- Never immerse the appliance in water.
- When in operation, the door and accessible external surfaces could become very hot. Always use the handgrip, handles and buttons. Use oven gloves if necessary.
- This electrical appliance operates at high temperatures which could cause burns.
- This appliance can be used by children aged from 8 years and above and persons with reduced physical, sensory or mental capabilities or lack of experience and knowledge if they have been given supervision or instruction concerning use of the appliance in a safe way and understand the hazards involved.

Children should be supervised to ensure that they do not play with the appliance. Cleaning and user maintenance shall not be made by children, unless they are more than eight years old and under constant supervision.

Keep the appliance and power cord away from children under eight years of age.

- Do not preheat the appliance when empty.
- Do not use the appliance without food. You might damage it.

- This is an household appliance only. It is not intended to be used in: staff kitchen areas in shops, offices and other working environments; farm houses; by clients in hotels, motels and other residential type environments; bed and breakfast type environments.
- This appliance must not be operated by a timer or a separate remote control system.



Danger!

Failure to observe the warning may result in life threatening injury by electric shock.

- Before using the appliance, check that the voltage of the mains power supply corresponds to the value indicated on the appliance rating plate.
- Connect the appliance to an earthed power supply and sockets with a minimum current rating of 10 A only. The manufacturer declines all liability in the event that this important accident-prevention rule is not respected.



Danger of burns!

Failure to observe the warnings could result in scalds or burns.

- While in operation, the appliance becomes hot. DO NOT LEAVE WITHIN REACH OF CHILDREN.
- Move the appliance by the handles only. Never move the appliance using the bowl handgrip.
- Never leave the power cord hanging from the edge of the surface the appliance is resting on where it could be grasped by a child or get in the way of the user.
- Hot steam may come out of the vents. Take great care!



Important!

Failure to observe the warnings may result in life threatening injury or damage to the appliance.

- Never locate the appliance near sources of heat.
- The bowl fits automatically onto the central pin. To avoid damage, never rotate it manually to find the right position.
- Never insert anything into the ventilation openings. Make sure they are unobstructed.
- Do not fill the bowl with liquid above the MAX level (E).
- Do not fill the bowl with quantities of oil in excess of the maximum level marked on the oil measure (level 5).



Please note:

This symbol identifies important advice or information for the

user.

- Before setting up the appliance, remove any paper and other material inside the appliance such as protective cardboard, booklets, plastic bags, etc.
- Before using the appliance for the first time, wash the bowl, paddle and lid in hot water and washing up liquid. At the end of the operation, dry all components thoroughly and remove any water left in the bottom of the bowl.
- It is normal for the appliance to give off a "new" smell when used for the first time. Ventilate the room.
- The appliance must be kept at a distance of at least 20 cm from the mains power socket to which it is connected.
- **During some cooking programmes, steam may leak from the lid. It should not therefore be positioned under kitchen cupboards or furniture (fig. 12).**

TECHNICAL DATA

size (LxHxD): 395x325x290 mm

weight: 5kg

For further information, see the rating plate on the appliance.

 The appliance complies with the following EC directives:

- Low Voltage Directive 2006/95/EC and subsequent amendments.
- European directive 2004/108/EC on electromagnetic compatibility and European regulation 1935/2004 of 27/10/2004 on food contact materials.
- European Standby Regulation 1275/2008.

DISPOSAL



In compliance with European directive 2002/96/EC, the appliance must not be disposed of with household waste, but taken to an authorised waste separation and recycling centre.

DESCRIPTION OF APPLIANCE

- A Lid
- B Hot air discharge grille (ventilation)
- C Viewing window release buttons
- D Removable viewing window
- E Maximum level MAX
- F Power cord
- G Condensate tray
- H Main ON/OFF button
- I Paddle
- J Ceramic coated bowl
- K Handle slide
- L Bowl handgrip
- M Oil measure (level from 1 to 5)

- N Luminous power level bar
- O Power level button
- P Timer button + (increases time)
- Q Display
- R Timer button - (decreases time)
- S Cooking programme selector dial
- T Luminous programme start/stop button
- U Appliance body
- V Handle for lifting the appliance
- W Lid open button
- X Condensate channel

COOKING PROGRAMMES

Automatic programmes: when one of the following programmes is selected, the default cooking time and optimum power levels are displayed.

These can, however, be changed according to the recipe or your personal requirements.



CASSEROLE RISOTTO: this programme is ideal for cooking all types of risotto and casserole.

The paddle (I) starts turning after about 3 minutes to ensure the food is evenly cooked (it should therefore be distributed evenly on the bottom of the bowl).

The default power level is  and the cooking time is 45 minutes. You can, however, modify the degree of cooking by using the power level button (O) and the cooking time by pressing the timer buttons + (P) and - (R) depending on your recipe.

When the lid (A) is opened, cooking is NOT interrupted and the remaining cooking time is still shown on the display (Q).



CAKE: this programme is ideal for cooking all types of cakes, muffins and biscuits.

You should always grease and flour the bowl (J) before inserting a cake. When cooking foods which can be turned during cooking, such as brioches or biscuits, use greaseproof paper.

The default power level is  and the cooking time is 40 minutes.

You can, however, modify the degree of cooking by using the power level button (O) and the cooking time by pressing the timer buttons + (P) and - (R) depending on your recipe.

This cooking programme uses much less energy than a traditional oven as it does not require pre-heating.

When the lid (A) is opened, cooking and the time set on the display (Q) are interrupted and will start again automatically when the lid is closed.



PIZZA: this programme is ideal for making crunchy pizzas

in the best Italian tradition.

When cooking home-made pizzas, you should always oil the bottom of the bowl (J), while to cook frozen pizzas, it is sufficient to use greaseproof paper.

The default power level is  and the cooking time is 30 minutes.

You can, however, modify the degree of cooking by using the power level button (O) and the cooking time by pressing the timer buttons + (P) and - (R) depending on your recipe.

When the lid (A) is opened, cooking and the time set on the display (Q) are interrupted and will start again automatically when the lid is closed.



POTATOES: this programme is particularly suitable for cooking any type of fresh or frozen potatoes, chips or croquettes.

There is a delay of a few minutes before the paddle (I) starts turning to avoid breaking the potatoes while still frozen.

The default power level is  and the cooking time is 32 minutes.

You can, however, modify the degree of cooking by using the power level button (O) and the cooking time by pressing the timer buttons + (P) and - (R) depending on your recipe.

When the lid (A) is opened, cooking and the time set on the display (Q) are interrupted and will start again automatically when the lid is closed.

Semi-automatic programmes: when one of the following programmes is selected, the default cooking times and basic power levels are displayed. These can then be modified according to the recipe and your personal requirements.



OVEN: this programme is ideal for cooking excellent crunchy fried foods such as scampi, cutlets, croquettes, etc. Coat in breadcrumbs before cooking.

It can also be used for roast meats, baked fish, bread and roast vegetables, with or without the paddle.

This cooking programme saves considerable energy as it does not require pre-heating.

The default power level is  and the cooking time is 60 minutes.

You can, however, modify the degree of cooking by using the power level button (O) and the cooking time by pressing the timer buttons + (P) and - (R) depending on your recipe.

When the lid (A) is opened, cooking and the time set on the display (Q) are interrupted and will start again automatically when the lid is closed.



AIRGRILL: this programme is recommended for cooking grilled meat, fish and vegetables. It is also excellent to complete cooking for foods which must be baked then browned.

The default power level is  and the cooking time is 40 minutes.

You can, however, modify the degree of cooking by using the power level button (O) and the cooking time by pressing the timer buttons + (P) and - (R) depending on your recipe.

When the lid (A) is opened, cooking and the time set on the display (Q) are interrupted and will start again automatically when the lid is closed.



PAN: This programme cooks in much the same way as a saucepan, with the advantage of the paddle which automatically mixes the food. It is excellent for soups, jams, braised foods, sauces, fruit drinks, boiled foods and lightly frying the ingredients for making meat and fish balls.

The default power level is  and the cooking time is 45 minutes.

You can, however, modify the degree of cooking by using the power level button (O) and the cooking time by pressing the timer buttons + (P) and - (R) depending on your recipe.

When the lid (A) is opened, cooking is NOT interrupted and the remaining cooking time is still shown on the display (Q).

USE





Please note: Before using the appliance for the first time, wash the bowl (J), paddle (I) and removable viewing window (D) in hot water and neutral washing up liquid.

Proceed as follows:

- Open the lid (A) by pressing the button (W) (fig. 1).
- Release the removable viewing window (D) by pressing the two buttons (C) (fig. 2).
- Lift the bowl handgrip (L) until you hear a "click" (fig. 3).
- Extract the bowl (J) by pulling upwards (fig. 4).
- Extract the paddle (I) from its housing (fig. 5).
- Wash the bowl (J), paddle (I) and removable viewing window (D) (fig. 6).
- At the end of the operation, dry all components thoroughly and remove any water left in the bottom of the bowl (J).
- Put the bowl (J) back in the appliance (U), making sure it is correctly positioned.
- Lower the bowl handgrip (L) using the slide (K) (fig. 7).
- **If required by the recipe**, insert the paddle (I), making sure it is correctly positioned on the pin at the bottom of the bowl (fig. 5).

- Place the ingredients to be cooked in the bowl (J), respecting the quantities given in the cooking tables/recipes.
- If required by the cooking procedure, add oil, referring to the quantities indicated in the cooking tables/recipes and using the measure (M).
- Close the lid (A).
- Plug the appliance into the mains socket.
- Turn the appliance on by pressing the main ON/OFF button (H).
- Turn the cooking programme selector dial (S) to the required position (fig. 8) (see cooking tables/recipes).
- Adjust the required degree of cooking by pressing the power level button (O) (fig. 9) (see cooking tables/recipes).
- Adjust the required cooking time by pressing the timer buttons + (P) and- (R) (fig. 10). The minutes set appear on the display (Q).
- Press the programme start/stop button (T). The light comes on (fig. 11).
- Cooking begins.
- At the end of the cooking time, the appliance emits two series of beeps. To turn the beeps off, press and hold the programme start/stop button (T).
- Turn the appliance off by pressing the ON/OFF button (H) again.
- Open the lid (A) and remove the bowl (J) containing the cooked food.
- Leave the lid (A) open to cool the appliance down more rapidly.

 **Please note:** In some programmes, to guarantee best results, the paddle (I) begins to turn a few minutes after cooking begins.

 **Please note:** During cooking, you can lift up the lid (A) to add ingredients or check cooking progress. The display flashes and ventilation stops briefly, then starts again when you close the lid. In functions without ventilation, cooking is not interrupted.

 **Please note:** If the programme start/stop button (T) has been pressed, extracting the bowl turns the appliance off. It starts functioning again when the bowl is reinserted.

 **Please note:** To reset the appliance, press and hold the programme start/stop button (T) for at least 2 seconds.

 **Please note:** Never use abrasive objects or detergents to clean the bowl (J). Clean with a soft cloth and neutral detergent only.

CLEANING AND MAINTENANCE





























 **Danger!** Before cleaning the appliance, always unplug from the mains socket and allow to cool. Never immerse the appliance in water and never place under running tap water. If water gets into the appliance, it could cause electric shock.

TROUBLESHOOTING

Fault	Cause/solution
The appliance does not heat up	The thermal cutout may have tripped. Contact Customer Experience, see enclosed guarantee or visit the Delonghi website (the device must be replaced)
The bowl is not positioned correctly and the appliance does not work	Position the bowl correctly
The lid is not properly closed and the appliance does not work	Close the lid properly
The paddle (E) does not turn	Wait for a few minutes after cooking begins
E1 is displayed and the appliance emits a series of 3 "beeps"	Turn the appliance off and allow to cool down, then check whether the appliance has been operated without food. If the fault persists, contact Customer Experience, see enclosed guarantee or visit the Delonghi website
E3 is displayed and the appliance emits a series of 5 "beeps"	Turn the appliance off and allow to cool down, then check whether the appliance has been operated without food. If the fault persists, contact Customer Experience, see enclosed guarantee or visit the Delonghi website
E5 is displayed and the appliance emits a series of 7 "beeps"	Contact Customer Experience, see enclosed guarantee or visit the Delonghi website
E6 is displayed and the appliance emits a series of 7 "beeps"	Contact Customer Experience, see enclosed guarantee or visit the Delonghi website









COOKING TABLES

Potatoes



















Recipe	Type	Quantity	Oil	Cooking time (min)	Paddle	Cooking programmes	Power level
Standard potatoes 10x10	Fresh	1700 gr (*)	level 5	40-43	YES		
		1500 gr (*)	level 4	37-40	YES		
		1250 gr (*)	level 3	35-37	YES		
		1000 gr (*)	level 2	28-31	YES		
		750 gr (*)	level 1	23-26	YES		
	Frozen	1500 gr	without	32-34	YES		
		1250 gr	without	30-32	YES		
		1000 gr	without	28-30	YES		
		750 gr	without	26-28	YES		
		500 gr	without	24-26	YES		
Roast potatoes	Fresh	1700 gr	level 3	40-43	YES		
Potato wedges	Frozen	1000 gr	without	30-32	YES		
New potatoes	Frozen	1200 gr	without	35-40	YES		
Baked croquettes	Frozen	750 gr	without	20-25	YES		

(*) un-peeled potato weight













First courses

Recipe	Type	Quantity	Oil	Cooking time (min)	Paddle	Cooking programmes	Power level
Risotto	Fresh	480 gr	level 5	15-18	YES		
Meat sauce	Fresh	1000 gr	level 5	60-65	YES		
Paella	Frozen	600 gr	without	13-15	YES		
Cannelloni	Fresh	1500 gr	without	40-45	NO		





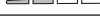



Meat - poultry

Recipe	Type	Quantity	Oil	Cooking time (min)	Paddle	Cooking programmes	Power level	Tips
Chicken nuggets	Frozen	750 gr	without	15-18	YES			-
Roast chicken drumsticks	Fresh	1000 gr	without	45-50	NO			turn 2-3 times
Casserole chicken drumsticks	Fresh	1000 gr	without	70-80	NO			turn 2-3 times
Veal stew	Fresh	600 gr	level 2	30-35	YES			-
Veal cutlets	Fresh	3 pcs	without	20-25	NO			turn after 15 min
Roast	Fresh	1000 gr	without	80-90	NO			turn 2-3 times
Kebabs	Fresh	800 gr	without	20-25	NO			turn 2-3 times
Hamburger	Fresh	4 pcs	without	15-20	NO			turn after 15 min
Meatballs	Fresh	450 gr	without	25-28	YES			-















Fish - Shellfish

Recipe	Type	Quantity	Oil	Cooking time (min)	Paddle	Cooking programmes	Power level
Fish fingers	Frozen	18 pcs	without	20-23	NO		
Slice of salmon	Fresh	400 gr	without	20-25	NO		
Fillet of salmon	Fresh	350 gr	without	20-25	NO		
Scallops	Fresh	4 pcs	without	15-17	NO		
Cuttlefish	Fresh	8 pcs	level 1	15-20	NO		
Tiger prawns	Fresh	600 gr	level 1	13-18	YES		
Prawns	Fresh	800 gr	level 1	15-20	YES		









Vegetables

Recipe	Type	Quantity	Oil	Cooking time (min)	Paddle	Cooking programmes	Power level
Courgettes	Fresh	800 gr	level 5	25-30	YES		
Aubergines	Fresh	1000 gr	level 3	25-30	YES		
Mushrooms	Fresh	1000 gr	level 5	20-25	YES		
Artichokes	Frozen	800 gr	level 3	35-40	YES		

Snacks

Recipe	Type	Quantity	Oil	Cooking time (min)	Paddle	Cooking programmes	Power level	Tips
Pizza	Fresh	300 gr	level 1	30	NO			oil the pan and turn through 180° after 20 min
	Frozen	450 gr	without	20-25	NO			urn through 180° after 15 min
Savoury pies and quiches	Fresh	600 gr	without	20-23	NO			usare carta da forno e ruotare di 180° dopo 15min
	Frozen	700 gr	without	45-50	NO			use greaseproof paper and turn through 180° after 30 min
Mini-pizzas	Frozen	14 pcs	without	20-25	NO			use greaseproof paper
Mini-savouries	Frozen	14 pcs	without	20-25	NO			use greaseproof paper
Onion rings	Frozen	12/15 pcs	without	10-15	NO			spread evenly on the bottom of the bowl

Desserts, cakes and pastries

Recipe	Type	Quantity	Oil	Cooking time (min)	Paddle	Cooking programmes	Power level	Tips
Tart	Fresh	700 gr	without	45-50	NO			-
Brioche	Frozen	4 pcs	without	25-30	NO			use greaseproof paper and turn through 180° after 12-13 min
Biscuits	Fresh	8 pcs	without	12-15	NO			use greaseproof paper and turn through 180° after 15 min
Strudel	Fresh	400 gr	without	20-25	NO			-