

the Bambino™

BES450/SES450



EN QUICK GUIDE

Sage®



Contents

2	Sage Recommends Safety First
9	Components
11	Features
11	Assembly
12	Functions
17	Care & Cleaning
20	Troubleshooting
23	Guarantee

SAGE RECOMMENDS SAFETY FIRST

At Sage we are very safety conscious. We design and manufacture consumer products with the safety of you, our valued customer, foremost in mind. In addition, we ask that you exercise a degree of care when using any electrical appliance and adhere to the following precautions.

IMPORTANT SAFEGUARDS

READ ALL INSTRUCTIONS BEFORE USE AND SAVE FOR FUTURE REFERENCE

- A downloadable version of this document is also available at sageappliances.com
- Carefully read all instructions before operating and save for future reference.
- Remove any packaging material and promotional labels or stickers safely before using the appliance for the first time.
- Before using for the first time, please ensure that your electricity supply is the same as shown on the rating label on the underside of the appliance. If you have any concerns, please contact your local electricity company.

- The installation of a residual current safety switch is recommended to provide additional safety when using all electrical appliances. Safety switches with a rated operating current not more than 30mA are recommended. Consult an electrician for professional advice.
- To eliminate a choking hazard for young children, discard the protective cover fitted to the power plug safely.
- Position the appliance on a stable, heat resistant, level, dry surface away from the counter edge, and do not operate on or near a heat source such as a hot plate, oven or gas hob.
- Fully unwind the power cord before operating.
- Do not let the power cord hang over the edge of a counter or table. Do not let the power cord touch hot surfaces or become knotted.
- Regularly inspect the power cord, plug and actual appliance for any damage. If found to be damaged in any way, immediately cease use of the appliance and return the entire appliance to the nearest authorised Sage Service Centre for examination, replacement or repair.
- Keep the appliance and accessories clean. Follow the cleaning instructions provided in this book. Any procedure not listed in this instruction booklet should be performed at an authorised Sage Service Centre.
- The appliance can be used by children aged 8 or older and persons with reduced physical, sensory or mental capabilities or a lack of experience

- and knowledge, only if they have been given supervision or instruction concerning use of the appliance in a safe way and understand the hazards involved.
- Children should not play with the appliance.
 - Cleaning of the appliance should not be carried out by children unless they are 8 years or older and under adult supervision.
 - The appliance and its cord should be kept out of reach of children aged 8 years and younger.
 - Do not use attachments other than those provided with the appliances.
 - Do not attempt to operate the appliance by any method other than those described in this booklet.
 - Do not move the appliance whilst in operation.
 - Never use the appliance without water in the water tank.
 - Ensure the portafilter is firmly inserted and secured into the brewing head before using the machine.
 - Never remove the portafilter during the brewing operation as the machine is under pressure.
 - Do not place anything on top of the appliance.
 - Do not touch hot surfaces. Allow the product to cool down before moving or cleaning any parts.
 - Heating element surface is subject to residual heat after use.
 - Always ensure the appliance is turned OFF, unplugged at the power outlet and has been allowed to cool before cleaning, attempting to move or storing.
 - The appliance is not intended to be operated by means of an external timer or separate remote-control system.

- The use of attachments not sold or recommended by Sage may cause fire, electric shock or injury.
- Always turn the appliance to the off position, switch off at the power outlet and unplug at the power outlet when the appliance is not in use.
- Any maintenance other than cleaning should be performed by an authorised Sage® service centre.
- Do not use the appliance on a sink drain board.
- Do not operate the appliance if it is in an enclosed space, or within a cupboard.

SPECIFIC INSTRUCTIONS FOR BES450/SES450

- This appliance is recommended for household use only. Do

not use this appliance for other than its intended use. Do not use in moving vehicles or boats. Do not use outdoors. Misuse may cause injury.

- If the appliance is to be:
 - left unattended
 - cleaned
 - moved
 - assembled; or
 - stored,

always switch Off the espresso machine by simultaneously pressing the 1 CUP and HOT WATER buttons. Unplug from the power outlet.

- Ensure the product is properly assembled before first use.
- Do not use any other liquid apart from cold mains/tap water. We do not recommend the use of highly filtered, de-mineralized or distilled water as this may affect the taste of the coffee and how the espresso

machine is designed to function.

- Do not leave the product unattended when in use.
- Do not touch hot surfaces. Allow the product to cool down before moving or cleaning any parts.
- Use caution when operating the machine, as metal surfaces are liable to get hot during use.

WARNING

To avoid the risk of injury, use caution when descaling, as hot steam may be released. Before descaling, ensure drip tray is inserted. Refer to 'Care & Cleaning' for further instructions.

Ensure the portafilter is firmly inserted and secured into the group head before starting the extraction. Never remove the portafilter during the brewing process.

WARNING

To avoid the risk of injury, do not open the brew chamber during the brew process.

WARNING

Do not place portafilter, the tamper or any parts of the appliance in the dishwasher.

WARNING

Do not immerse power cord, power plug or any parts of the appliance or the appliance in water or any other liquid.

WARNING

Misuse may cause injury.

SHORT CORD INSTRUCTIONS

- Your Sage appliance is fitted with a short power cord to reduce personal injury or property damage resulting from pulling, tripping or becoming entangled with a longer cord. Longer detachable power cords or

extension cords are available and may be used if care is exercised. If an extension cord is used,

1. the marked electrical rating of the cord set, or extension cord should be at least as great as the electrical rating of the appliance,
2. the cord should be arranged so that it will not drape over the counter-top or table where it can be pulled on by children or tripped over unintentionally and
3. the extension cord must include a 3-prong grounding plug.

NOTICE TO CUSTOMERS REGARDING MEMORY STORAGE

- Please note that in order to better serve our customers, internal memory storage has been imbedded into your appliance. This memory storage consists of a small chip to collect certain information about your appliance including the frequency of use of the appliance and the manner in which your appliance is being used. In the event your appliance is returned for service, the information collected from the chip enables us to quickly and efficiently service your appliance.
- The information collected also serves as a valuable resource in developing future appliances to better serve the needs of our consumers. The chip does not collect any information regarding the

individuals who use the product or the household where the product is used. If you have any questions regarding the memory storage chip, please contact us at privacy@sageappliances.com

SPECIFIC INSTRUCTIONS FOR WATER FILTER

- Filter cartridge should be kept out of reach of children.
- Store filter cartridges in a dry place in the original packaging.
- Protect cartridges from heat and direct sunlight.
- Do not use damaged filter cartridges.
- Do not open filter cartridges.

- If you are absent for a prolonged period of time, empty the water tank and replace the cartridge.



The symbol shown indicates that this appliance should not be disposed of in normal household waste. It should be taken to a local authority waste collection centre designated for this purpose or to a dealer providing this service. For more information, please contact your local council office.



To protect against electric shock, do not immerse the power cord, power plug or appliance in water or any other liquid.

FOR HOUSEHOLD USE ONLY SAVE THESE INSTRUCTIONS



Components

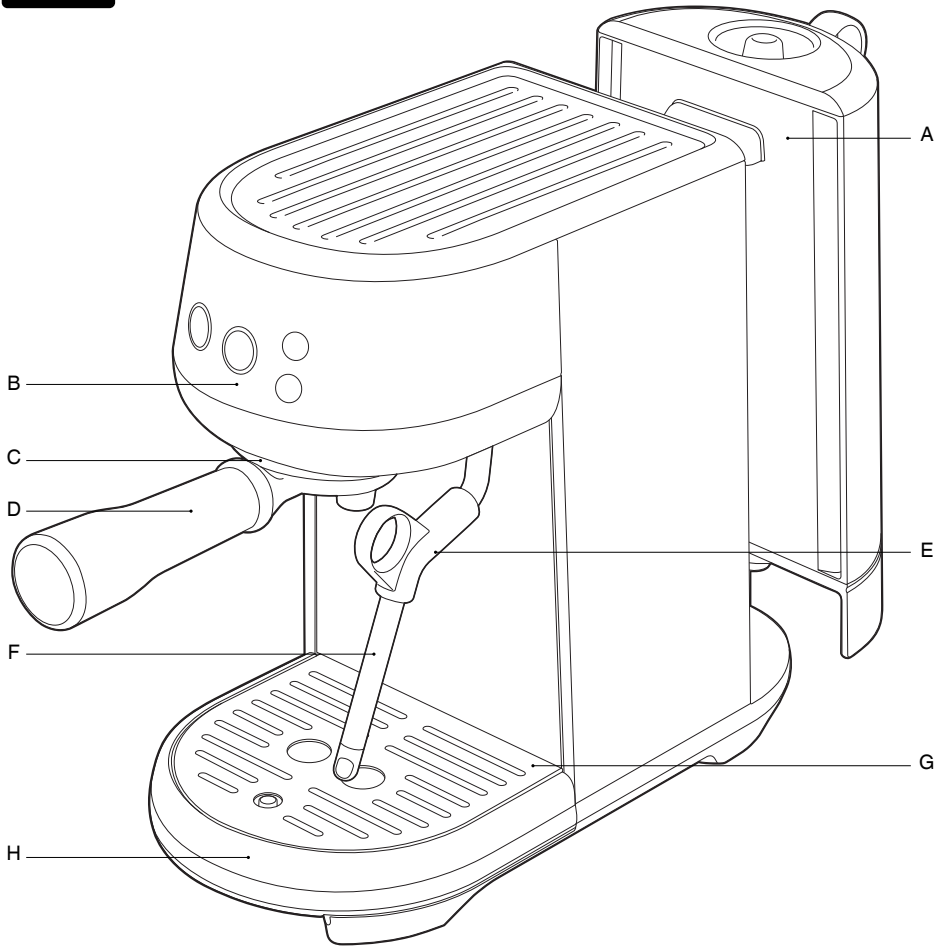

A. 1.4L (47 fl.oz) removable water tank

B. Control panel

1 CUP, 2 CUP, hot water, steam buttons

C. Group head

D. 54mm aluminum portafilter

(WARNING: NOT dishwasher safe)

E. Steam wand grip

F. Steam wand

G. Removable drip tray grid

H. Removable drip tray with full indicator

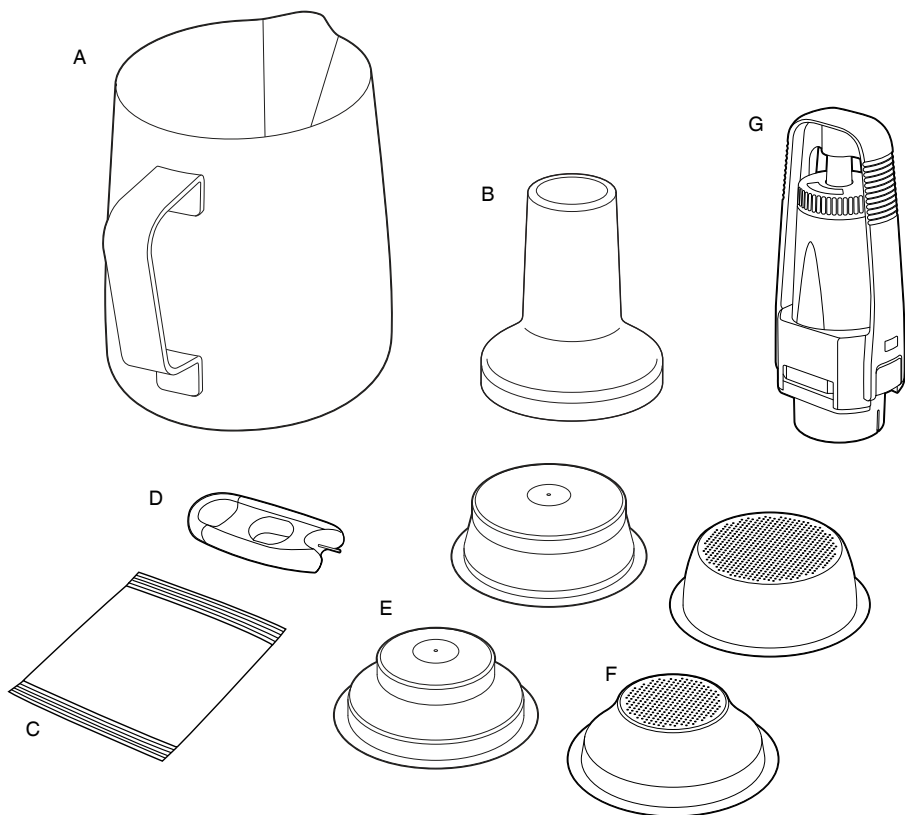

ACCESSORIES

A. Stainless steel milk jug

B. 54mm tamper

(Note: Do not submerge in water or any liquid)

C. Descaling Powder

D. Steam tip and basket cleaning tool

(Located under the water tank)

E. Dual wall filter baskets (1 cup & 2 cup)

F. Single wall filter baskets (1 cup & 2 cup)

G. Water filter holder with filter



Rating Information

220-240V ~50-60Hz 1300-1600W



Bambino™ Features

COMPACT FOOTPRINT

Cafe quality coffee in a compact machine.

MANUAL MILK TEXTURING

Manually textures milk from silky smooth latté to creamy cappuccino.

THERMOJET™ TECHNOLOGY

Innovative heating system achieves ideal extraction temperature in 3 seconds.

PID TEMPERATURE CONTROL

Electronic PID temperature control for increased temperature stability.

LOW PRESSURE PRE-INFUSION

Applies low water pressure at the start of the extraction to gently expand grinds for an even extraction.

VOLUMETRIC CONTROL

Preset 1 & 2 cup volumes, manual over-ride or programmable shot volumes.

INSTANT HOT WATER

Hot water outlet via the steam wand for making long blacks and pre-heating cups.



Assembly

BEFORE FIRST USE

Machine Preparation

Remove and discard all labels and packaging materials attached to your machine. Ensure you have removed all parts and accessories before discarding the packaging.

Clean the drip tray, drip tray grid, portafilter, filter baskets using warm water and a gentle dish washing liquid. Rinse well and dry thoroughly before use.



INSTALLING THE WATER FILTER

1. Remove the water filter and water filter holder from the packaging.
2. Set the reminder for the next month of replacement. We recommend to replace the filter after 3 months.

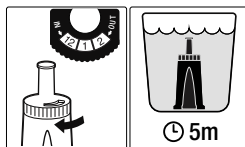

3. Soak the filter in cold water for 5 minutes.
4. Wash the filter holder with cold water.

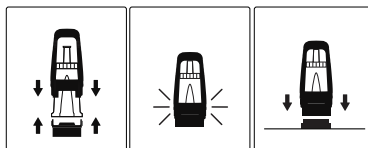

5. Insert the filter into the two parts of the filter holder. Ensure they are connected.
6. Remove the water tank from the machine. Align the base of the filter holder with the adapter inside the water tank. Push down to lock into place.



Functions

FIRST USE

1. Remove the water tank and fill it with potable water to the indicated MAX line. Place the water tank back firmly onto the machine.
2. Ensure that the drip tray is firmly placed on the machine.
3. Place a 500ml container under the portafilter and steam wand for the water drips for this first cycle.
4. Plug the power cord into the power outlet, and the 1 Cup button illuminates.

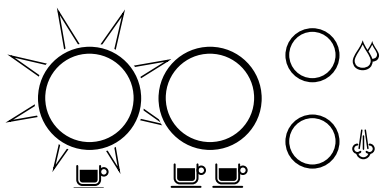

5. Press the 1 Cup button to begin the first use cycle.



NOTE

The first use cycle is to rinse the machine and prime the heating system.

STANDBY MODE

To turn off the operation and enter standby mode, press the 1 Cup and Hot Water buttons for 0.5 second simultaneously.



NOTE

Unit will enter 'standby mode' when idle or no interaction from user after 10 minutes.

FILLING THE WATER TANK

Lift the water tank from the machine. Remove the water tank lid and add potable water to the water tank, filling to the MAX marking indicated.

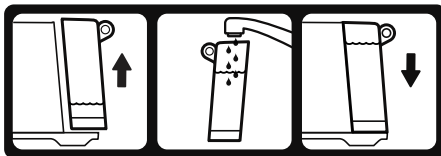

Replace the water tank onto the machine, press down ensuring it is properly attached and sitting flush against the back of the machine.



NOTE

Machine LED lights will flash 6 times for 3 seconds when no water is detected in the water tank.

FILTER BASKETS

This machine includes both single and dual wall 1 Cup and 2 Cup filter baskets.

Use the 1 cup filter basket when brewing a single cup and the 2 cup filter baskets when brewing 2 cups or a stronger single cup or mug.

Adjust the grind amount and size if switching from a single basket to a double basket, or vice versa.

The provided filter baskets are designed for:

1 Cup filter basket = 8-11g

2 Cup filter basket = 16-19g

SINGLE WALL FILTER BASKETS

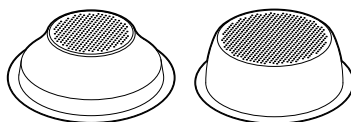

1 CUP

2 CUP

Single Wall filter baskets should be used when grinding fresh whole coffee beans. These allows you to experiment with grind, dose and tamp to create a more balanced espresso.

DUAL WALL FILTER BASKETS

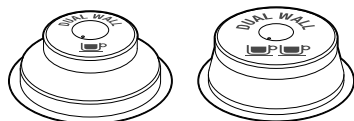

1 CUP

2 CUP

Dual Wall filter baskets should be used when using pre-ground coffee and older beans that are past the 30 day roast date. These regulate the pressure and helps to optimise the extraction regardless of the grind, dose and tamp pressure or freshness.

THE GRIND

When grinding coffee beans, the grind size should be fine but not too fine. The grind size will affect the rate at which the water flows through the ground coffee in the filter basket and the taste of the espresso.

If the grind is too fine (looks like powder and feels like flour when rubbed between the fingers), the water will not flow through the coffee even when under pressure. The resulting espresso will be **OVER EXTRACTED**, dark in colour and bitter in flavour.

If the grind is too coarse, the water will flow through the ground coffee in the filter basket too quickly. The resulting espresso will be **UNDER EXTRACTED** and lacking in colour and flavour.

COFFEE DOSE AND TAMPING

- Insert the filter basket into the portafilter.
- Grind enough coffee to fill the filter basket.
- Tap the portafilter several times to collapse and distribute the coffee evenly in the filter basket.

- Using the tamper, tamp down firmly (approx. 15-20kgs (30-40 lbs.) of pressure). The amount of pressure is not as important as the consistent pressure every time.

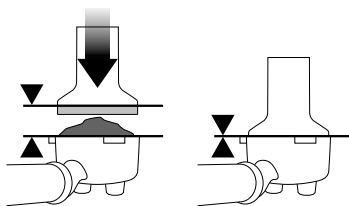

As a guide, the top edge of the cap on the tamper should be level with the top of the filter basket **AFTER** the coffee has been tamped.

NOTE

We recommend quality 100% Arabica beans with a 'Roasted On' date stamped on the bag, not a 'Best Before' or 'Use By' date. Coffee beans are best consumed between 5-20 days after the 'Roasted On' date. Stale coffee may pour too quickly from the portafilter spouts and taste bitter and watery.

PURGING THE GROUP HEAD

Before placing the portafilter into the group head, run a short flow of water through the group head by pressing the 1 Cup or 2 Cup button. This will stabilize the temperature prior to extraction.

INSERTING THE PORTAFILTER

Place the portafilter underneath the group head so that the handle is aligned with the **INSERT** position. Insert the portafilter into the group head and rotate the handle towards the centre until resistance is felt.

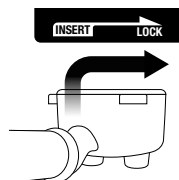

Place your cup/s under the portafilter on the drip tray.

EXTRACTING ESPRESSO

As a guide the espresso will start to flow after 8–12 seconds (infusion time) and should be the consistency of dripping honey.

If the espresso starts to flow after less than 7 seconds, you have either under dosed the filter basket and /or the grind is too coarse. This is an **UNDER EXTRACTED** shot.

If the espresso starts to drip but doesn't flow after 12 seconds, the grind is too fine. This is an **OVER EXTRACTED** shot.

PRE-PROGRAMMED SHOT VOLUME - 1 CUP

Press the 1 Cup button for less than 1 second, the button will flash indicating that it has been selected. A preset single espresso volume of approximately 30ml will be extracted. The machine will automatically stop once the pre-set volume has been extracted.

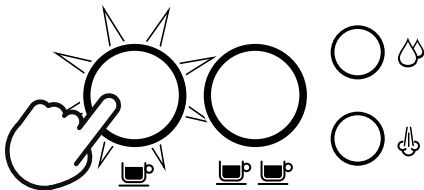

PRE-PROGRAMMED SHOT VOLUME - 2 CUP

Press the 2 Cup button for less than a second, the button will flash indicating that it has been selected. A preset double espresso volume of approximately 60ml will be extracted. The machine will automatically stop once the pre-set volume has been extracted.

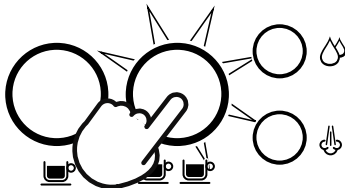

NOTE

Pressing the corresponding 1 Cup or 2 Cup button during the programmed espresso extraction will immediately stop the extraction.

PROGRAMMING COFFEE VOLUME

Press and hold the 1 Cup and 2 Cup buttons for 2 seconds, the buttons will illuminate and flash.



To set the 1 Cup volume:

- Press the 1 Cup button for about 3 seconds to start the extraction.
- Press the 1 Cup button again to stop the extraction. The modified volume will be saved.

To set the 2 Cup volume, follow the above steps and select the 2 Cup button to start and stop the extraction.

NOTES

- If no user input after 30 seconds. Machine returns to 'ready mode'
- The modified coffee volume will be saved into memory for the next use or when the machine is re-started.
- Pressing the steam or hot water button at any stage will cancel the operation and the machine will return to ready mode without saving any coffee volume program.

MANUAL PRE-INFUSION AND SHOT VOLUME

Press and hold the 1 Cup or 2 Cup button for more than a second. After one second the pump will start at pre-infusion pressure and continue while button is pressed. Release the button to start the extraction. Press any button again to stop the extraction.

MANUAL MILK TEXTURING

- Lift the steam wand and insert into the milk jug with the steam wand tip 1-2cm ($\frac{3}{4}$ inch) below the surface of the milk, close to the right-hand side of the jug at a 3 o'clock position.
- Press the STEAM button to begin texturing

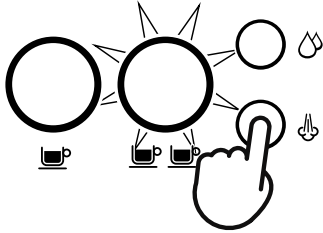

- Keep the steam wand tip just under the surface of the milk until the milk is spinning clockwise, producing a vortex (whirlpool effect).
- With the milk spinning, slowly lower the jug. This will bring the steam wand tip to the surface of the milk and start to introduce air into the milk.
- Gently break the surface of the milk with the tip to get the milk spinning fast enough.
- Keep the steam wand tip at or slightly below the surface, continuing to maintain the vortex. Texture the milk until sufficient volume is obtained.
- Lift the jug to lower the tip beneath the surface but keep the vortex spinning. The milk is at the correct temperature (60-65°C) when the jug is hot to touch.

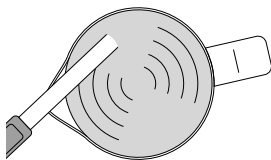

- When texturing is close to acceptable desired result, press any button to stop texturing.
- After the steam is released completely, remove the steam wand from the milk jug.
- Wipe the wand and tip with a clean damp cloth.

STEAM WAND MANUAL PURGE

To reduce steam wand blockages, we recommend running steam through the steam wand after milk texturing. Lower and point steam wand directly on drip tray and away from users and press the steam button to run steam to rinse steam wand, or press and hold steam button for 3 seconds, to activate the steam wand purge. This will run short water pulses through the steam wand.



NOTE

Both 1 Cup and 2 Cup buttons will blink during the steam purge function.



WARNING

After pressing steam button, the steam can't stop immediately, it needs a few seconds to completely stop steam.

STEAM WAND BLOCKED

Regularly check steam performance. If the steam wand is blocked, it will immediately stop operating. See 'Cleaning the Steam Wand' for further instructions.

HOT WATER OPERATON

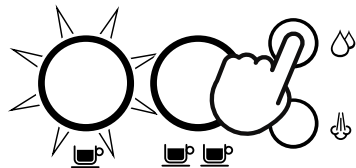

Hot water through the steam wand

When machine is on 'ready mode', press hot water button, and hot water flow will start through the steam wand. Press any button to stop hot water flow.





WARNING

Cup temperature is at 90°C (194°F). Be careful in handling hot beverages.

EXTRACTION TIPS

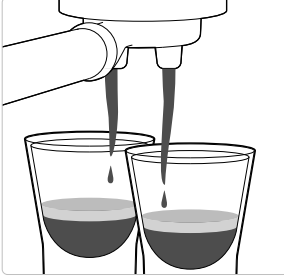
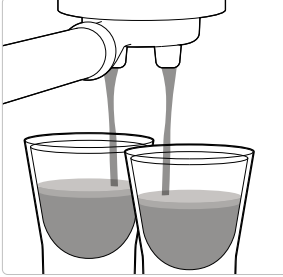
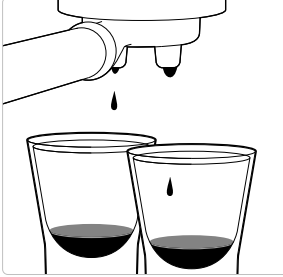
A great espresso is about achieving the perfect balance between sweetness, acidity, and bitterness. The flavour of your coffee will depend on many factors, such as the type of coffee beans, degree of roast freshness, coarseness or fineness of the grind, dose of ground coffee and tamping pressure. Experiment by adjusting these factors just one at a time to achieve the taste of your preference.

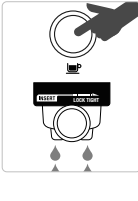
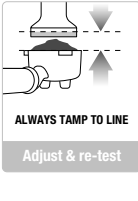
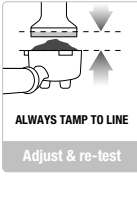
CORRECT EXTRACTION	UNDER EXTRACTION	OVER EXTRACTION
		
<ul style="list-style-type: none"> • Flow starts after 8–12 secs • Flow slow like warm honey • Crema is golden brown with a fine mousse texture • Espresso is dark brown 	<ul style="list-style-type: none"> • Flow starts after 1–6 secs • Flow fast like water • Crema is thin and pale • Espresso is pale brown • Tastes bitter/sharp, weak and watery 	<ul style="list-style-type: none"> • Flow starts after 12 secs • Flow drips or not at all • Crema is dark and spotty • Espresso is very dark brown • Tastes bitter and burnt
<p>AFTER EXTRACTION</p>	<p>SOLUTIONS</p>	<p>SOLUTIONS</p>
<p>REMOVE USED GRINDS</p> <p>Used grinds will form a coffee 'puck'. If the puck is wet, refer to the 'Under Extraction' section.</p> 	<p>EXPERIMENT WITH GRIND:</p> <ul style="list-style-type: none"> • Grind needs to be finer for a slower extraction. • Ensure you are controlling the dose. <p>Adjust & re-test</p>	<p>EXPERIMENT WITH GRIND:</p> <ul style="list-style-type: none"> • Grind needs to be coarser for a faster extraction. • Ensure you are controlling the dose. <p>Adjust & re-test</p>
<p>RINSE FILTER BASKET</p> <p>Keep the filter basket clean to prevent blockages. Without ground coffee in the filter basket, lock the portafilter into the machine and run hot water through.</p> 	<p>Tamp using 15–20kgs of pressure. The top edge of cap on the tamper should be level with the top of the filter basket AFTER tamping.</p>  <p>ALWAYS TAMP TO LINE</p> <p>Adjust & re-test</p>	<p>Tamp using 15–20kgs of pressure. The top edge of cap on the tamper should be level with the top of the filter basket AFTER tamping.</p>  <p>ALWAYS TAMP TO LINE</p> <p>Adjust & re-test</p>

	GRIND	GRIND DOSE	TAMP
OVER EXTRACTED BITTER • ASTRINGENT	Too fine	Too much Decrease dose	Too heavy
BALANCED	Optimum	8-11g (1 Cup) 16-19g (2 Cup)	15-20kgs (30-40 lbs.)
UNDER EXTRACTED UNDERDEVELOPED • SOUR	Too coarse	Too little Increase dose	Too light



Care & Cleaning

CLEAN & DESCALE CYCLE

The Bambino Espresso machine requires regular cleaning and descaling.

When this is due, the 2 Cup button will continuously flash, indicating the machine needs cleaning and descaling.



NOTE

Pressing any of buttons will cancel the alert and return the machine to ready mode.



WARNING

It is NOT recommended to ignore the clean cycle warning because after regular use, hard water can cause mineral build-up in and on many of the inner functioning components, reducing the brewing flow, brewing temperature, power of the machine, and the taste of the espresso.



WARNING

Do not immerse the power cord, power plug or appliance in water or any other liquid. The water tank should never be removed or completely emptied during descaling.

TO PERFORM A CLEAN & DESCALE CYCLE

1. Empty the drip tray and re-insert firmly into position on the machine.
2. Fill the water tank to the DESCALE line indicated and add the descaling agent to the water.

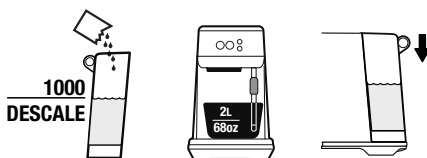

3. Place a 2 Litre (68 fl.oz) container under the group head and steam wand.

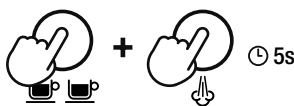

4. Press the 2 Cup and Steam buttons simultaneously for 5 seconds to start descaling.

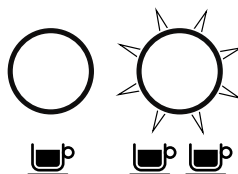

NOTE

The 2-Cup button will flash throughout the cycle.

5. Once the descale solution has been used up, the descale mode will pause.
6. Rinse and refill the water tank to the MAX line and empty the waste water container, then replace both parts on to the machine to proceed onto the rinse cycle.
7. Press the 2 Cup button to proceed rinse cycle.
8. When the rinse cycle is complete, the machine will then go into ready mode.

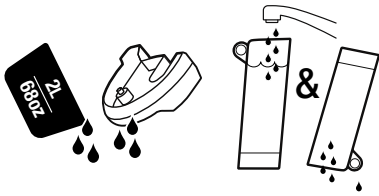

- Remove and empty the waste water container. Rinse the drip tray and water tank and dry thoroughly before replacing them back onto the machine.



CLEANING THE STEAM WAND

- The steam wand should always be cleaned after texturing milk. Wipe the steam wand with a damp cloth.
- If any of the holes in the tip of the steam wand become blocked, it may reduce frothing performance. Manually purge the steam wand to try and clear the holes.
- If the steam flow is very small and steam wand is still blocked, unscrew the steam wand tip using the steam tip cleaning tool, then use the tool to unblock the holes; cleaning tool is located in the back of the machine, under the water tank.

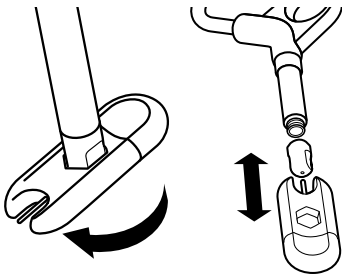

Rinse the steam tip and wipe with a clean, dry cloth. Reassemble the steam wand by screwing the steam tip back on to the steam wand. Purge the steam wand after cleaning.

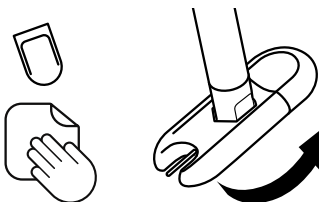

GROUP HEAD RINSE

- Press '2 Cup' button to flow freshwater flush cycle.

CLEANING THE FILTER BASKETS AND PORTAFILTER

- The filter baskets and portafilter should be rinsed under hot water directly after use to remove all residual coffee oils.
- If the holes in the filter baskets become blocked, use the steam wand cleaning tool to unblock the holes.



WARNING

Do not put portafilter in dishwasher.

CLEANING THE SHOWER SCREEN

- The group head interior and shower screen should be wiped with a damp cloth to remove any ground coffee particles.
- Periodically run hot water through the machine with the filter basket and portafilter in place, without any ground coffee, to rinse out any residual coffee.

CLEANING THE DRIP TRAY

The drip tray should be removed, emptied and cleaned after each use or when the drip tray indicator rises through the drip tray grid. Remove the drip tray grid and wash both parts in warm soapy water.

CLEANING THE OUTER HOUSING

- Wipe the outer housing with a soft, damp cloth and then polish with a soft, dry cloth.



NOTE

Do not use any abrasive cleaners, pads or cloths which can scratch the surfaces of the machine.



NOTE

Do not clean any of the parts or accessories in the dishwasher.



WARNING

Do not immerse the power cord, power plug, plastic tamp or machine in water or any other liquid.

STORING YOUR MACHINE

Before storing, turn the machine off, switch off and remove the power plug from the power outlet. Empty the water tank and drip tray and ensure the machine is cool, clean and dry. Store in an upright position.

Do not place anything on top of the machine.

RESET FACTORY ESPRESSO VOLUME SETTINGS

1. When machine is on standby mode
2. Press and hold the 1 Cup and 2 Cup buttons for 10 seconds to enter Factory reset mode.
3. The lights will flash 3 times to indicate that all volumes have been reset.
4. Machine will then return to ready mode.



NOTE

When machine is turned on after reset, it enters directly to ready mode.



REPLACING THE WATER FILTER

The provided water filter helps prevent scale build-up in and on many of the inner functioning components. Replacing the water filter after 3 months or 40L will reduce the need to descale the machine.

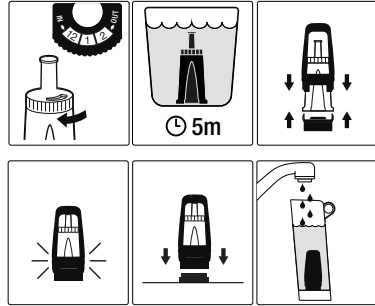



Troubleshooting

PROBLEM	POSSIBLE CAUSES	EASY SOLUTION
Water does not flow from the group head. No hot water.	<ul style="list-style-type: none">• Water tank is empty.• Water tank is not fully inserted and locked into position.• Machine needs to be cleaned & descaled.• Coffee is ground too finely and/ or too much coffee in filter basket and/or over tamping and/or filter basket is blocked.	<ul style="list-style-type: none">• Fill tank.• Push water tank down completely to lock into place.• Perform clean & descale cycle.• See below, 'Espresso only drips from the portafilter spouts or not at all'.
Espresso only drips from the portafilter spouts or not at all.	<ul style="list-style-type: none">• Coffee is ground too finely.• Too much coffee in the filter basket.• Coffee tamped too firmly.• Water tank is empty. Fill tank.• Water tank is not fully inserted and locked into position.• The filter basket may be blocked.• Machine needs to be cleaned & descaled.	<ul style="list-style-type: none">• Use slightly coarser grind. Refer to 'Coffee Dose and Tamping' on page 13 and 'Extraction Tips' on page 16.• Lower dose of coffee.• Tamp between 15-20kgs (30-40 lbs) of pressure.• Fill tank.• Push water tank down completely to lock into place.• Use the pin on the end of the provided cleaning tool to unblock the hole(s).• Perform clean & descale cycle
Espresso runs out too quickly	<ul style="list-style-type: none">• Coffee is ground too coarsely.• Not enough coffee in the filter basket.• Coffee tamped too lightly.	<ul style="list-style-type: none">• Use slightly finer grind.• Refer to 'Coffee Dose and Tamping' on page 13 and 'Extraction Tips' on page 16.• Increase dose of coffee and tamp. Refer to 'Coffee Dose and Tamping' on page 13 and 'Extraction Tips' on page 16.• Tamp between 15-20kgs (30-40 lbs) of pressure.

PROBLEM	POSSIBLE CAUSES	EASY SOLUTION
Espresso runs out around the edge of the portafilter.	<ul style="list-style-type: none"> • Portafilter not inserted in the group head correctly. • There are coffee grounds around the filter basket rim. • Too much coffee in the filter basket. 	<ul style="list-style-type: none"> • Ensure portafilter is completely inserted and rotated until resistance is felt. • Clean excess coffee from the rim of the filter basket to ensure a proper seal in group head. • Lower dose of coffee. Refer to 'Coffee Dose and Tamping', page 13
Small steam.	<ul style="list-style-type: none"> • Machine has not reached operating temperature. • Water tank is empty. • Water tank is not fully inserted and locked into position. • Machine needs to be cleaned & descaled. • Steam wand is blocked or almost blocked. 	<ul style="list-style-type: none"> • Allow time for the machine to reach operating temperature. • Fill tank. • Push water tank down completely to lock into place. • Perform clean & descale cycle. • Refer to 'Cleaning the Steam Wand', page 18.
Pulsing/pumping sound while extracting espresso or steaming milk.	<ul style="list-style-type: none"> • The machine is carrying out the normal operation of the pump. • Water tank is empty. 	<ul style="list-style-type: none"> • No action required as this is the normal operation of the machine. • Fill tank.
Coffee not hot enough.	<ul style="list-style-type: none"> • Portafilter not pre-heated. 	<ul style="list-style-type: none"> • Rinse portafilter under hot water outlet. Dry thoroughly.
No crema.	<ul style="list-style-type: none"> • Coffee tamped too lightly. • Coffee is ground too coarsely. • Coffee beans or pre-ground coffee are not fresh. • The filter basket may be blocked. 	<ul style="list-style-type: none"> • Tamp between 15-20kgs (or 30-40 lbs) of pressure. • Use slightly finer grind. Refer to 'Coffee Dose and Tamping' on page 13 and 'Extraction Tips' on page 16. • If grinding fresh whole coffee beans, use freshly roasted coffee beans with a 'Roasted On' date and consume between 5–20 days after that date. If using pre-ground coffee, use within a week of grinding. • Use the pin on the end of the provided cleaning tool to unblock the hole(s).
Water leaking	<ul style="list-style-type: none"> • Manual purge • Water tank is not fully inserted and locked into position. 	<ul style="list-style-type: none"> • Turn the steam wand directly on the drip tray or jug before manual purge. • Push water tank down completely to lock into place.

PROBLEM	POSSIBLE CAUSES	EASY SOLUTION
Water doesn't come through (the machine makes a loud noise).	<ul style="list-style-type: none"> • Water tank is empty or water level is below minimum. • Water filter has been inserted without soaking. 	<ul style="list-style-type: none"> • Fill tank • Ensure the water filter has been soaked for 5 minutes before inserting into the water tank.
Machine is on but ceases to operate.	<ul style="list-style-type: none"> • The safety thermal-cut out may have activated due to the pump overheating. 	<ul style="list-style-type: none"> • Press the 1 CUP and HOT WATER buttons simultaneously for 0.5 seconds to switch the machine off and unplug from the power outlet. Allow to cool for about 30–60 minutes. If problem persists, call Sage Support.
2-cup coffee button flashing	<ul style="list-style-type: none"> • This indicates machine needs cleaning and descaling 	<ul style="list-style-type: none"> • Perform a clean and descale cycle. Follow the steps outlined on page 17.
Too much/too little espresso is being delivered to the cup.	<ul style="list-style-type: none"> • Grind amount and/or grind size settings and/or shot volumes require adjustment. 	<ul style="list-style-type: none"> • Adjust the grind amount and/or grind size settings. Refer to 'Coffee Dose and Tamping', page 13, 'The Grind', page 13 and 'Extraction Tips', page 16.



Guarantee

2 YEAR LIMITED GUARANTEE

Sage Appliances guarantees this product for domestic use in specified territories for 2 years from the date of purchase against defects caused by faulty workmanship and materials. During this guarantee period Sage Appliances will repair, replace, or refund any defective product (at the sole discretion of Sage Appliances).

All legal warranty rights under applicable national legislation will be respected and will not be impaired by our guarantee. For full terms and conditions on the guarantee, as well as instructions on how to make a claim, please visit www.sageappliances.com.

GBR

BRG Appliances Limited
Unit 3.2, Power Road Studios,
114 Power Road, London, W4 5PY
Freephone (UK Landline): 0808 178 1650
Mobile Calls (National Rate): 0333 0142 970

IRE

Ireland
1800 932 369

ESP

Spain
0900 838 534

ITL

Italy
800 909 773

POR

Portugal
0800 180 243

DEU

AUT

Sage Appliances GmbH
Campus Fichtenhain 48, 47807 Krefeld,
Deutschland

Deutschland: 0800 505 3104
Österreich: 0800 80 2551

BEL

Belgium
0800 54 155

NO

Norway
80 024 976

NLD

Netherlands
0800 020 1741

SE

Sweden
0200 123 797

FRA

Sage Appliances France SAS
Siège social: 66 avenue des Champs
Elysées – 75008 Paris

879 449 866 RCS Paris
France: 0800 903 235

LUX

Luxembourg
0800 880 72

DK

Denmark
080 820 827

CHE

Switzerland
0800 009 933

FI

Finland
0800 412 143

Sage®

www.sageappliances.com

Registered in England & Wales No. 8223512
Registered in Germany No. HRB 81309 (AG Düsseldorf)
Registered in France No. 879 449 866 RCS

EN Due to continued product improvement, the products illustrated or photographed in this document may vary slightly from the actual product.

DEU Aufgrund unserer kontinuierlichen Produktverbesserungen kann die hier gezeigte Abbildung geringfügig vom tatsächlichen Produkt abweichen.

FRA En raison de leur amélioration continue, les produits représentés ou photographiés dans le présent document peuvent différer légèrement du produit réel.

ITL A causa del continuo miglioramento dei prodotti, il prodotto descritto o illustrato in questo documento può variare leggermente rispetto al prodotto reale.

NLD Vanwege voortdurende productverbeteringen, kunnen de afgebeelde producten in dit document licht afwijken van het eigenlijke product.

ESP Perfeccionamos nuestros productos continuamente, por lo que el artículo podría diferir ligeramente de la ilustración o la fotografía en este documento.

POR Devido à melhoria continua dos produtos, os produtos ilustrados ou fotografados neste documento podem variar ligeiramente do produto real.

DK På grund af løbende produktudvikling kan de illustrerede eller fotograferede produkter i dette dokument variere en smule fra det faktiske produkt.

SE På grund av kontinuerlig produktförbättring kan produkterna som visas i illustrationerna och fotografierna i detta dokument skilja sig något från den faktiska produkten.

FI Jatkuvan tuotekehittelyn seurauksena kuvituksen tuotteet eivät välttämättä ole täysin samanlaisia kuin varsinaiset tuotteet.

NO På grunn av kontinuerlig produktutvikling kan produktene som er vist eller avfotografert i dette dokumentet, variere noe fra det faktiske produktet.

Copyright BRG Appliances 2021

BES450 / ES450 UG1 - G21