

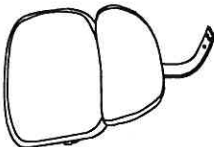

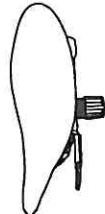

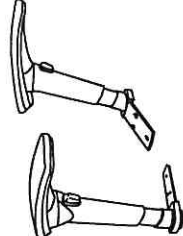
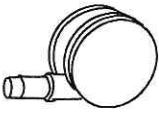
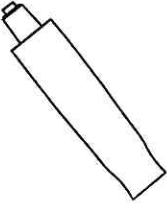

MODEL: CYM35-A CYM35-C CYM35HR-2

(1)x1 	(2)x1 	(3)x1 (1)x1 (D) 
Back Cushion (4)x5 	Seat Cushion & Mechanism (5)x1 	Left-Arm-L Right-Arm-R (6)x1 
(A)x6 	(C)x2 	
(B)x3 	(D)x2 	
	(E)x1 	



Insert and loosely tighten all screws. When assembly is completed, fully tighten all screws before using. This chair is only intended for sitting. Any other use will void the warranty.

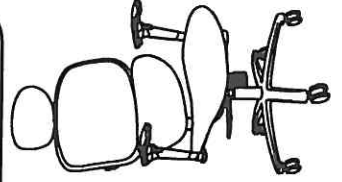
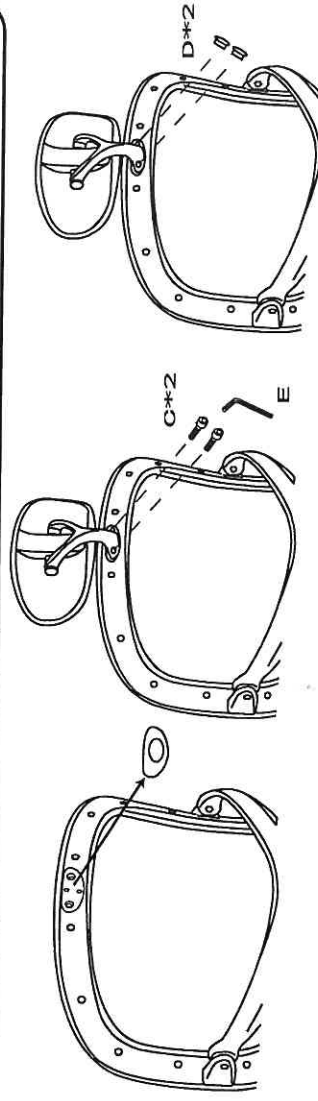
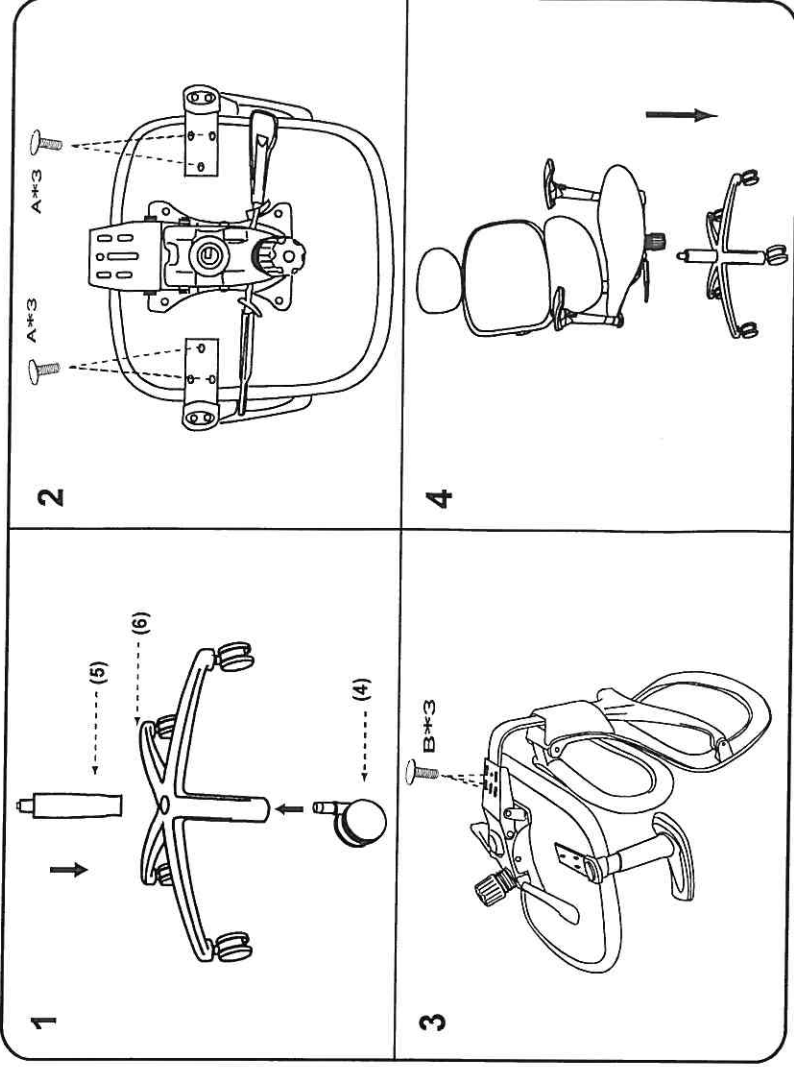

1. Remove the plastic cover on the back.
2. Follow the directional "Arrows" point to insert the headrest mount.
3. Follow the directional "Arrows" point to put the insert cover on.